

Historia zmian			
LP	Opis	Data	Zatwierdził

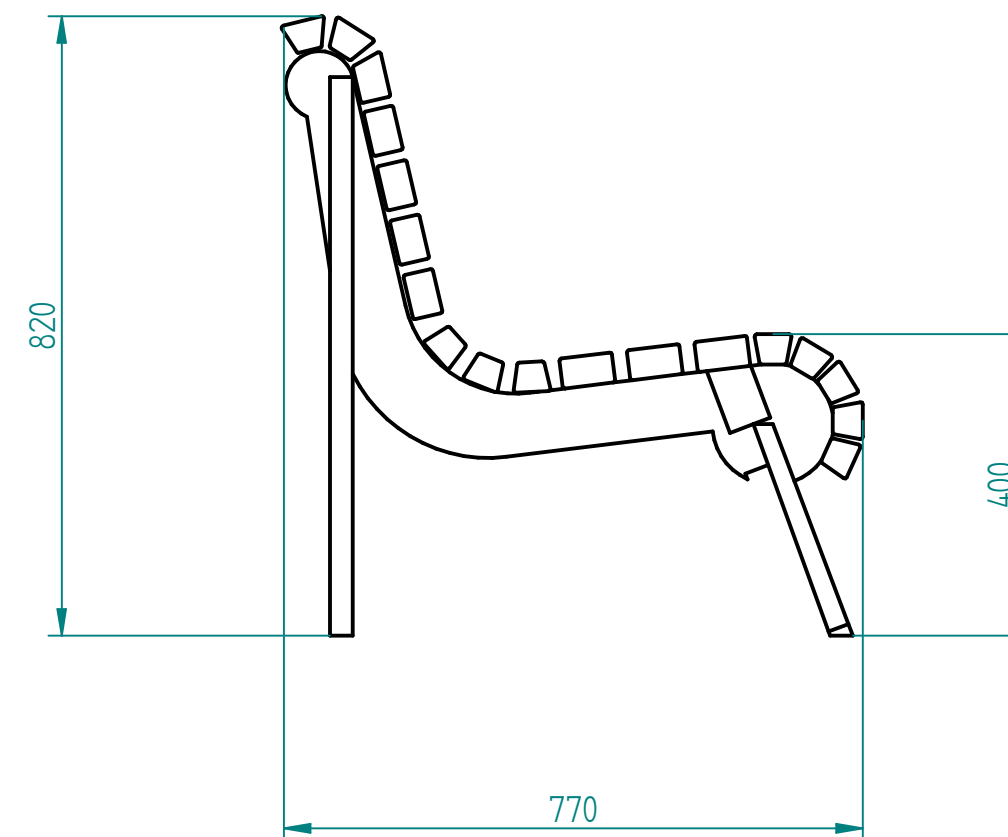

SOLID EDGE HOME USE

10.01.2017	Imię, Nazwisko:	 PUCZYŃSKI mała architektura
Projektował:	Mariusz	
Rysował:	Mariusz	
Sprawdził:	Mariusz	
05-800 Pruszków ul. Robotnicza 31 tel.: 22 7586693 info@puczynski.pl www.puczynski.pl		Nazwa pliku: Nr: ławka
roz.: A3	Numer rysunku: DFT: 13-04-27.dft	zm.:
		13-04-27.asm
Skala arkusza: 1:10		Masa: 0,000 kg
		Arkusz 1 z 1